

微型課桌椅

七年級生活科技—蔡依帆老師、張祐瓏老師

修改課本P.128左上角圖面尺寸

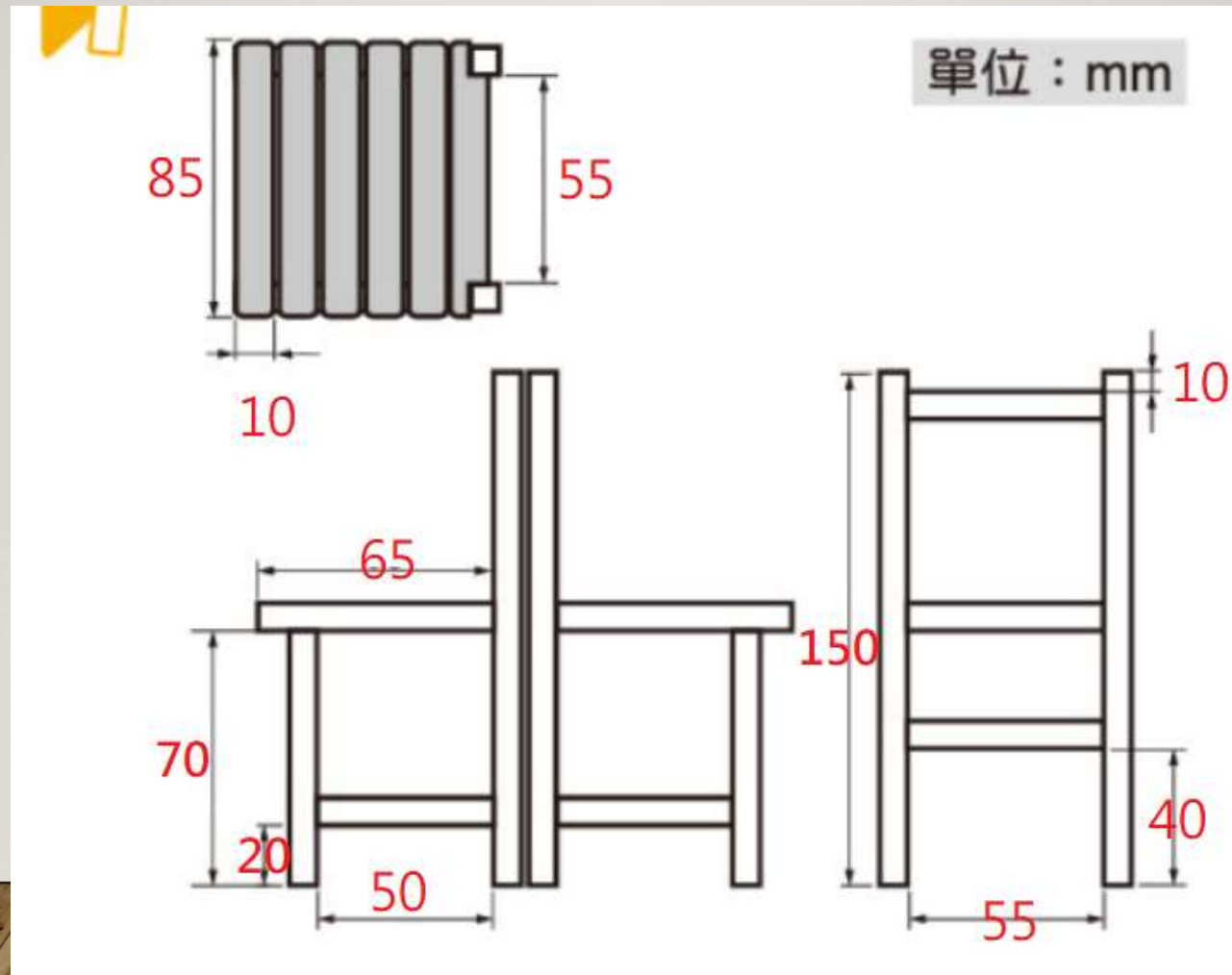

使用藍本方格紙繪製三視圖

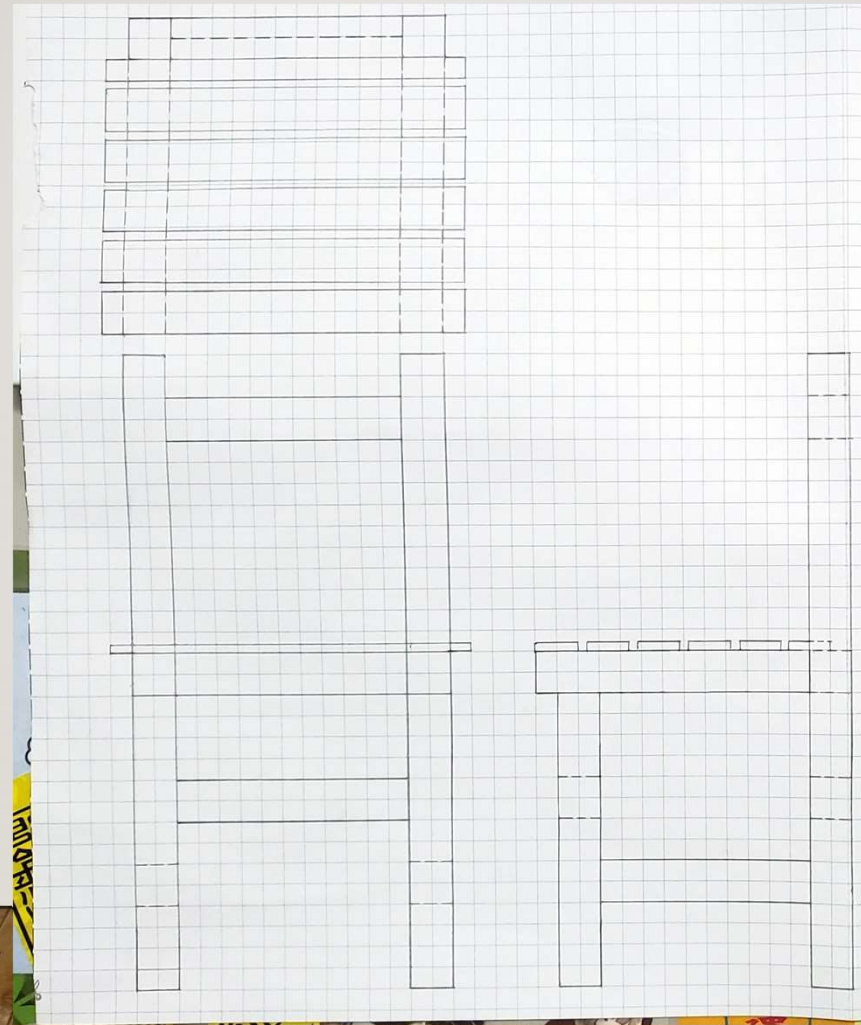

前視圖

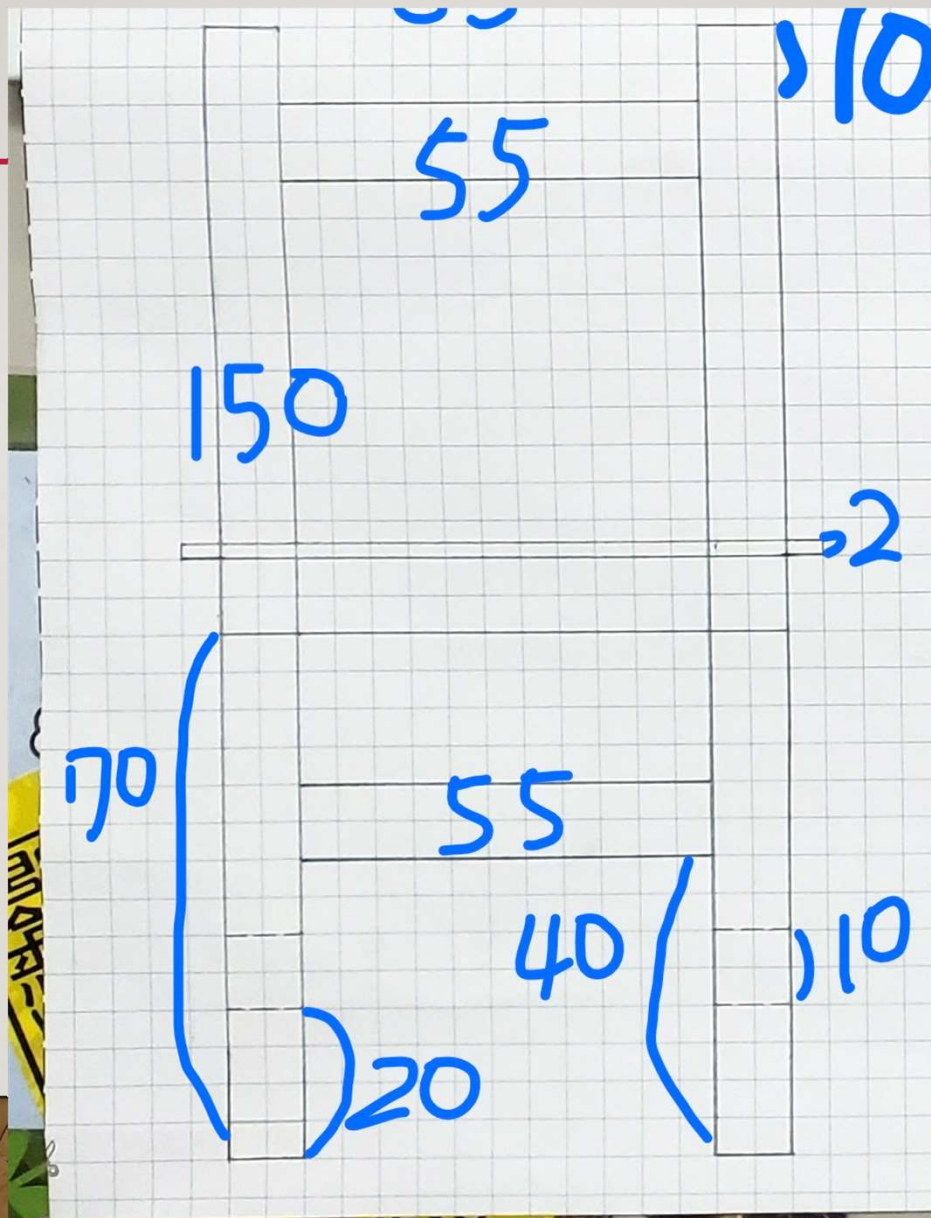

右側視圖

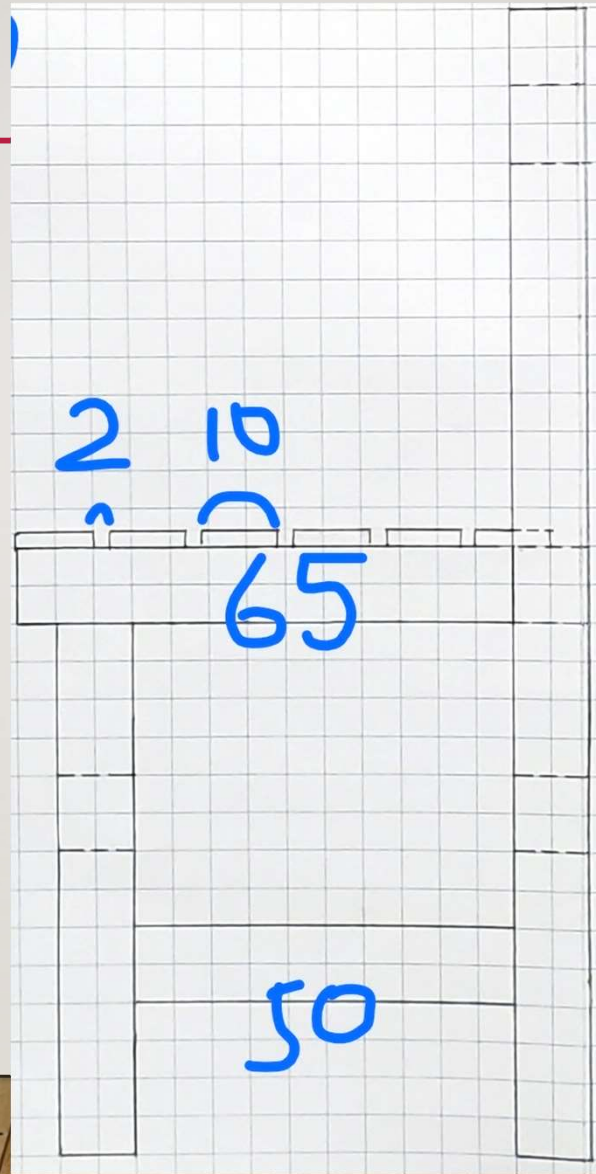

俯視圖

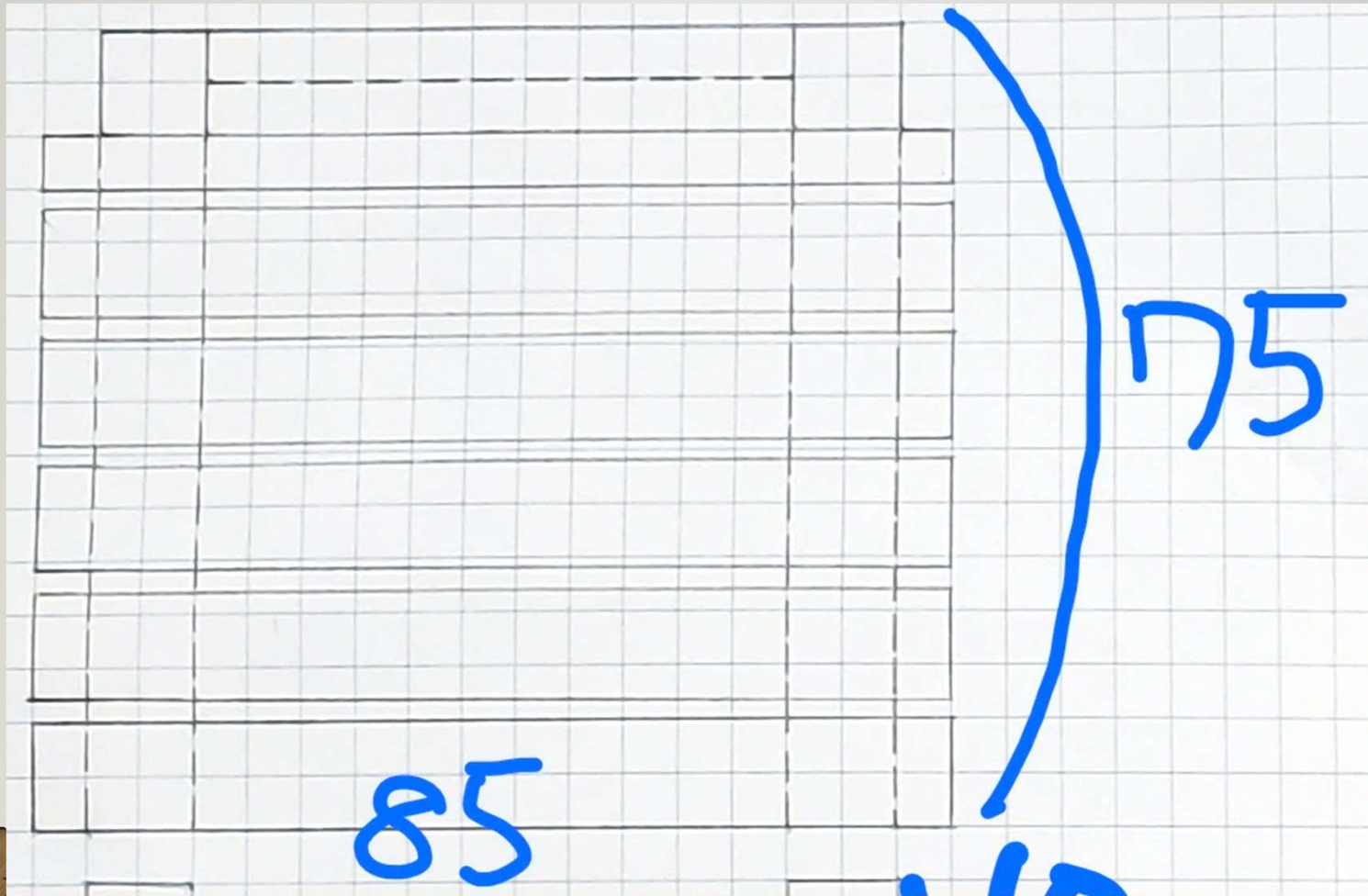

計算所需要的零件(木條、冰棒棍)

材料名稱	長度(cm)	數量
10mm*10mm方木條	150	2
	70	2
	65	2
	55	4
	50	2
10mm冰棒棍	85	6

使用鋼尺、直角規在木條上劃記



零件之間要
預留**鋸路**
大約0.5mm

工具的使用



康軒 國中科技

活動製作
鋸切

也是對齊剛剛的那個記號

使用F夾、手線鋸將零件鋸下

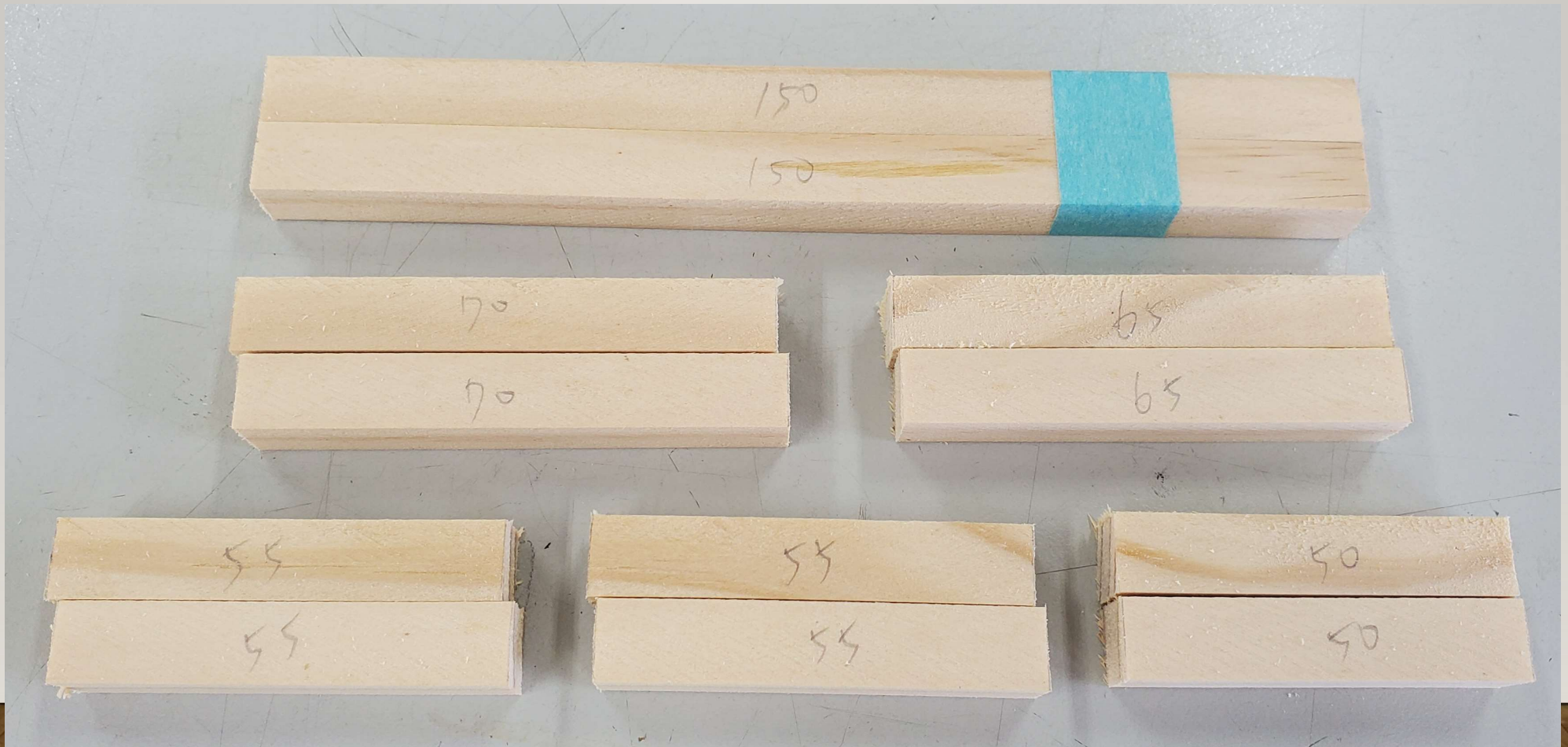

使用砂紙稍微修整鋸切面



一定要
保持垂直

也可以用剪刀把少許毛邊剪掉



利用圖面黏合木條零件(不要黏到紙)

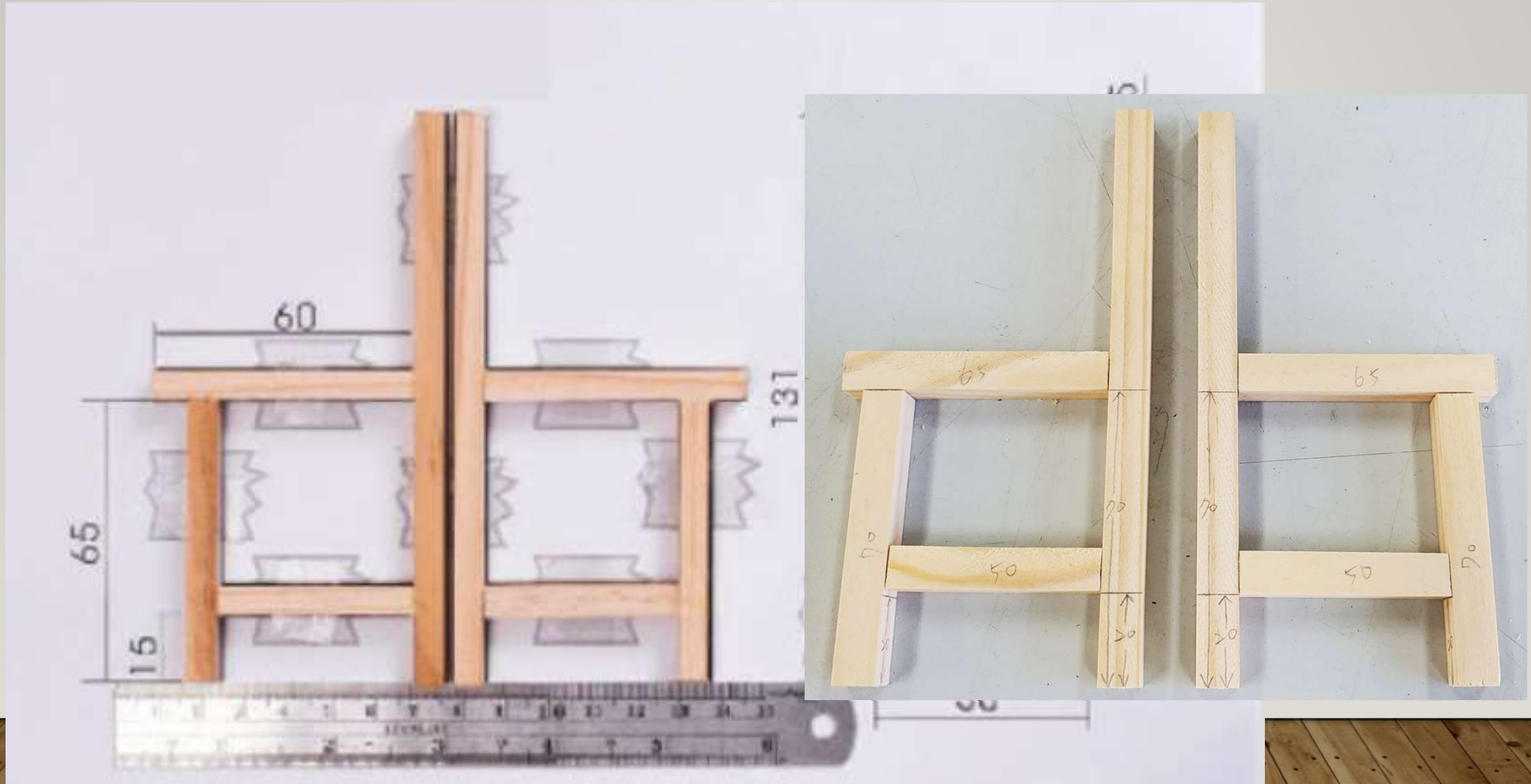

利用圖面黏合木條零件(不要黏到紙)

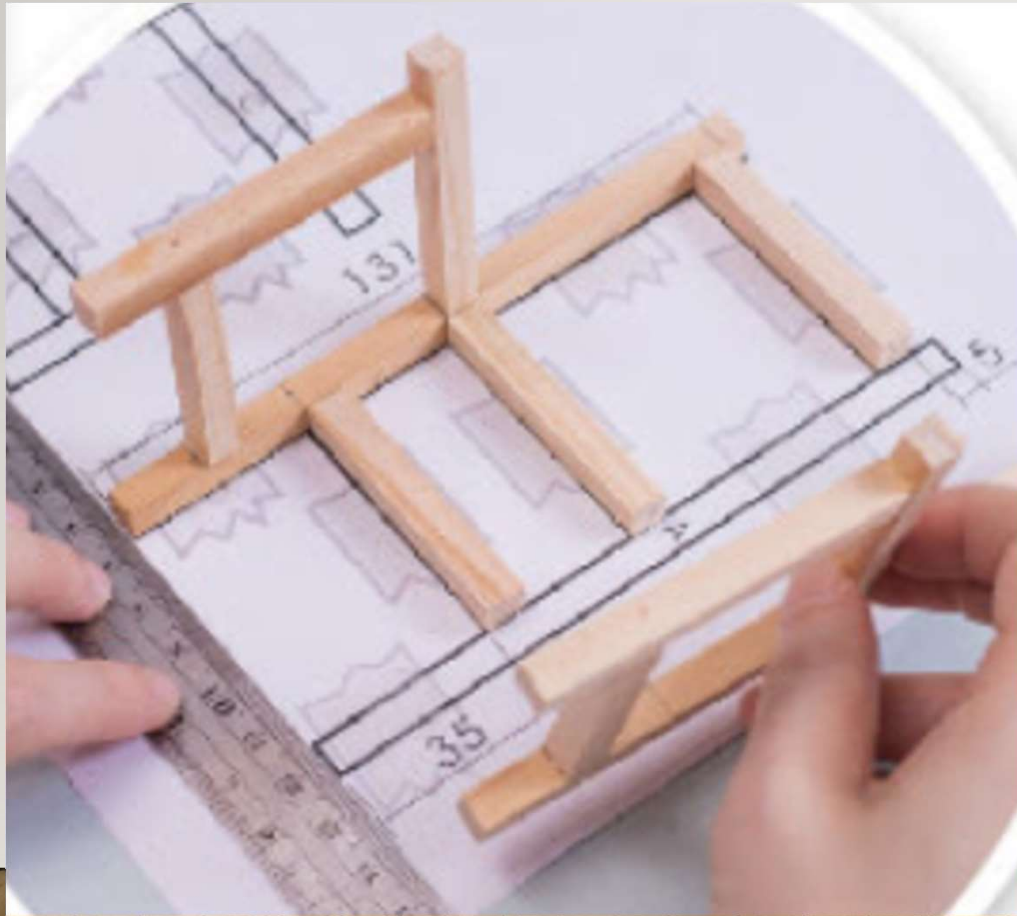

用紙膠帶捆緊冰棒棍鋸切至85MM



劃記之後鋸掉一個L型缺口



把剩下的椅面黏上去，完成

